

Introduction

Customer demands for higher levels of graphic performance are also driving Accelerated Graphics Port (AGP) initiatives to higher performance levels. This upward performance spiral places greater demands on bus speeds and data rates that in turn place greater demands on the system power supplies.

The ISL6529 addresses these needs by providing two independent voltage programmable regulators. One regulator is a high current synchronous buck converter topology and the other is a linear regulator.

Figure 1 shows the Evaluation Board. Power is supplied to the board via the ATX connector. Switch SW1 to the right of the ATX connector controls the ATX power supply. When the switch is in the upward position towards the PC board SW1 label, the ATX supply is activated.

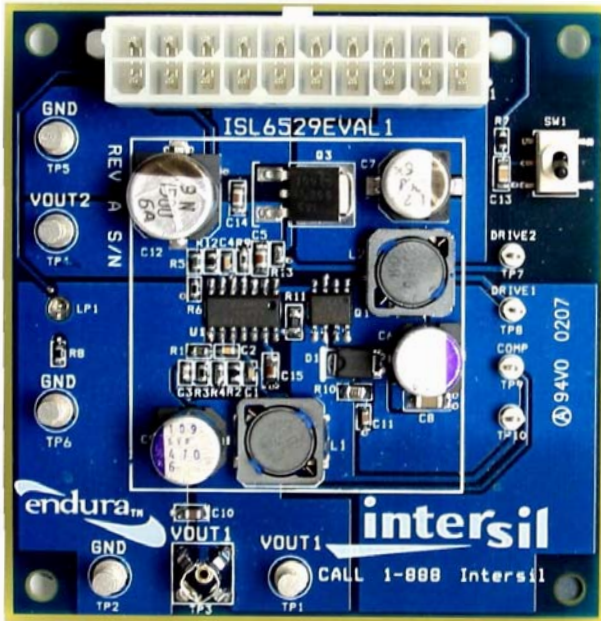

FIGURE 1. ISL6529 EVALUATION BOARD

Intersil ISL6529

The ISL6529 regulates two output voltages and provides simple protection functions for both outputs. The integrated PWM controller drives two external N-Channel MOSFET transistors in a synchronous buck converter topology. This regulator is intended to support GPUs or embedded processor loads. The integrated linear controller drives an external N-Channel MOSFET pass transistor in a standard linear regulator configuration, typically regulating the local memory voltage bus required by most GPUs or embedded processors

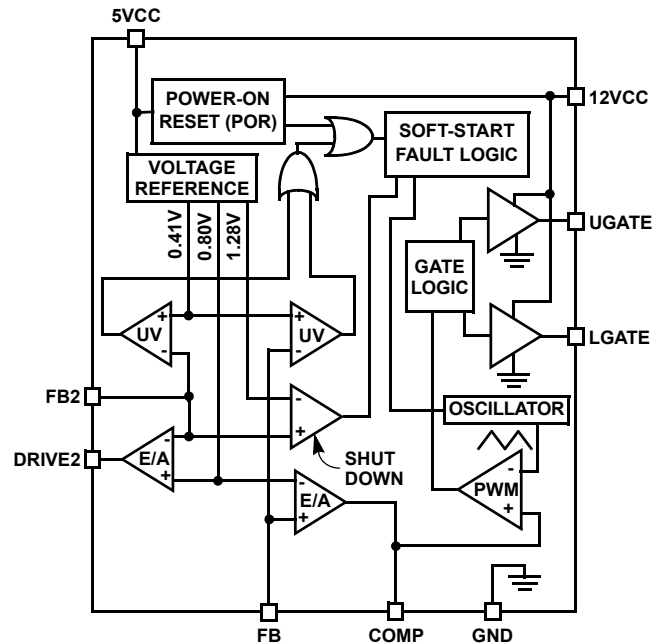

FIGURE 2. ISL6529 BASIC BLOCK DIAGRAM

A simple block diagram of the ISL6529 is shown in Figure 2. Integrated high-bandwidth error amplifiers and an accurate internal voltage reference insures static voltage regulation of $\pm 2\%$ for the ISL6529C and $\pm 1\%$ for the ISL6529AC over line, load and temperature ranges. Simple undervoltage (UV) comparators monitor the FB lines of each regulator and shut down both outputs when a fault is detected on either FB input. For a more detailed description of the ISL6529 functionality, refer to the ISL6529 Data Sheet [1].

The ISL6529EVAL1 Reference Design

The ISL6529EVAL1 evaluation board is intended to provide a versatile platform for evaluation of this device with surface mount components. The synchronous buck converter is capable of 6A continuous load current and handling $2.5A/\mu s$ load current transients. The linear regulator is designed to supply 1A of continuous load current and transient currents up to 3A. A LED power-on indicator is illuminated when the board is power by the ATX supply. The board is implemented with a 2-ounce copper on a 2-layer, printed circuit board. See page 6 for layout plots.

Quick Start Evaluation

Circuit Setup

The ISL6529EVAL1 does not require any jumper settings and a simple on-board switch toggles the ATX PS_ON# power-on control input. Make sure the on-board ATX switch, SW1, is pointed toward the bottom of the PC board. This will keep the ATX supply off while connections are made to critical test points. Remember that the ATX +5VDC output and the +3.3VDC output must be loaded to at least 0.3A to insure that all ATX outputs are within specifications.

Input Power Connections

The 20-pin ATX header, J1, mates with a standard ATX power supply connector. Place the ATX switch towards the lower portion of the board to insure that no inadvertent connections cause damage to the board while mating the connector to the board. Toggle the ATX switch towards the SW1 label on the top of the board to release the PS_ON# input to the ATX supply and power the evaluation board. Once the ATX outputs are up, the red LED indicator, LP1, will begin illuminating when the ATX PWR_OK output transitions high.

If regular bench supplies are used, an ATX extension cable can be modified by paralleling and bringing out all the grounds, 3.3V, 5V and the single 12V line. It is important to make sure all lines are connected. Note that SW1 will not inhibit operation and LP1 will not be illuminated when using bench supplies.

The two regulator outputs can be exercised using either resistive or electronic loads. Connections for the synchronous buck converter output are twin posts, TP1 and TP2, labeled VOUT1 and GND respectively. A shielded scope probe test point, TP3, between TP1 and TP2 allows for accurate observation of the output voltage with minimum of extraneous pick-up from switching signals. The linear regulator output posts, TP4 and TP5, are labeled VOUT2 and GND. An additional ground post, TP6 is located next to the power indicator lamp, LP.

ISL6529EVAL1 Performance

Soft-Start Interval

Powered by a standard ATX power supply, Figure 3 shows the controlled start-up of both regulators on the ISL6529EVAL1. The soft-start interval begins when the voltage applied to 5V VCC increases beyond the power-on reset rising threshold of 4.4V typically and the 12V input is above typically 10.4V. During the soft-start interval both outputs slowly ramp up to their proper voltage levels. VOUT1 begins normal regulation at 1.6V and VOUT2 at 2.57V. The soft-start interval lasts about 3ms. This controlled ramping of both output voltages and supply currents reduces the stress on the systems powered by these regulators and the ATX supply.

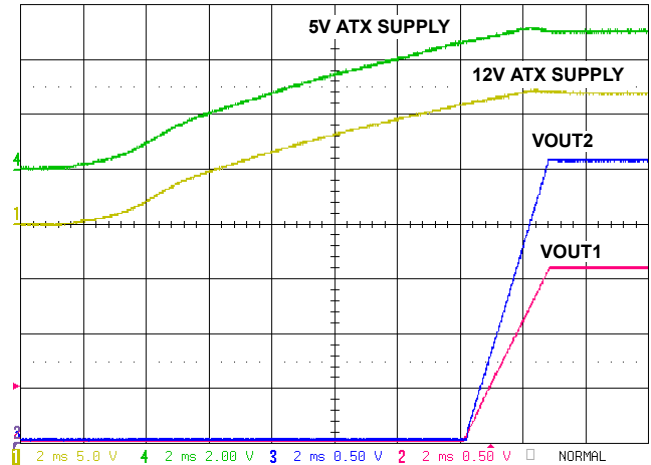

FIGURE 3. SOFT-START WAVEFORMS

Transient Response

The expected GPU transient slew rate of 2.5A/ μ s allows the ISL6529 synchronous buck converter to support loads up to 6A.

The leading edge transient response of the ISL6529 EVAL1 board is captured in Figure 4.

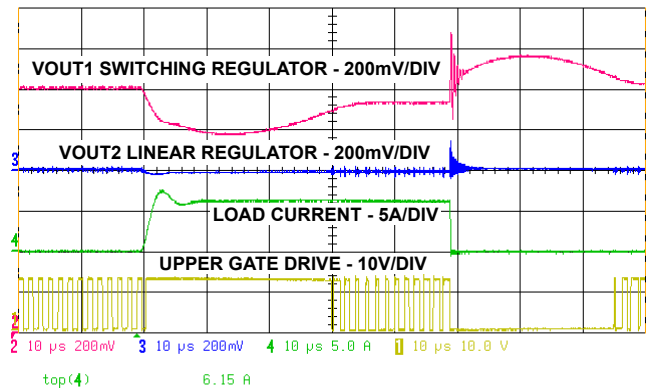

FIGURE 4. SWITCHING REGULATOR RESPONSE TO 6A TRANSIENT LOADING

The core voltage immediately drops when the transient is applied as the bulk and ceramic output capacitors begin to support the output voltage. The controller detects the new load level by the drop in output voltage and responds by pushing the PWM output to maximum duty cycle. Note on the falling edge as the load is removed the PWM output goes to minimum duty cycle until the output voltage drops to the defined regulated voltage, where the PWM resumes normal operation.

Figure 5 shows similar response by the linear regulator. Notice that both regulators are conservatively compensated at the cost of slower transient response. Refer to the ISL6529 data sheet for techniques to optimize regulator response.

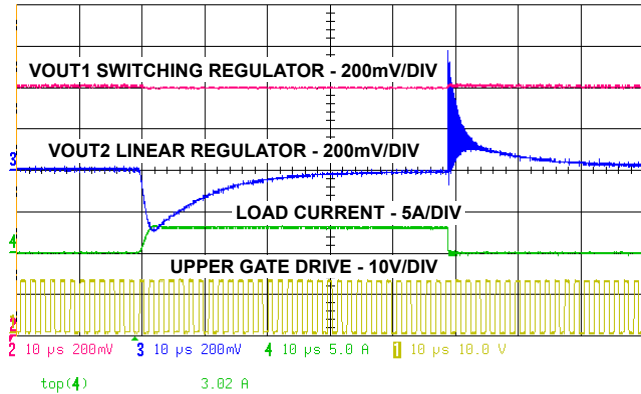

FIGURE 5. LINEAR REGULATOR RESPONSE TO 3A TRANSIENT LOADING

Undervoltage Protection

The ISL6529 monitors the feedback voltage on both FB pins to detect if either output is less than 52.5% of the reference voltage. This feature provides simple short circuit protection of both outputs. If one output voltage does drop below the UV threshold, then both outputs are quickly shut down. The outputs are held low for a set delay interval of about 10.5ms and then a normal soft-start interval is attempted. The UV protection circuitry becomes active 1ms into the new soft-start interval and if the output does not rise above the UV threshold, then both outputs are again shut down. This hiccup mode cycle is repeated until both outputs soft-start normally or power to the controller is removed.

Figure 6 shows this operation of the converter when a hard short is applied across the output terminals of VOUT1. Both outputs are quickly shut down and three separate soft-start intervals are attempted after brief delay intervals.

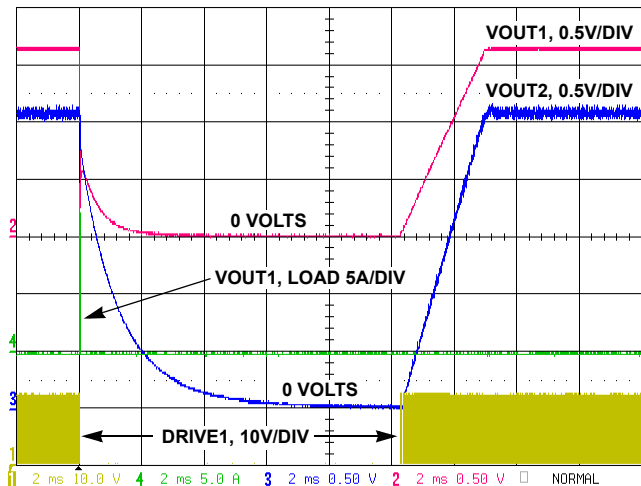

FIGURE 6. UNDERVOLTAGE PROTECTION

Efficiency

The performance of the ISL6529EVAL1 board loaded from 1A to 6A is plotted in Figure 7. The measurements were made at thermal equilibrium under room temperature conditions with no air flow.

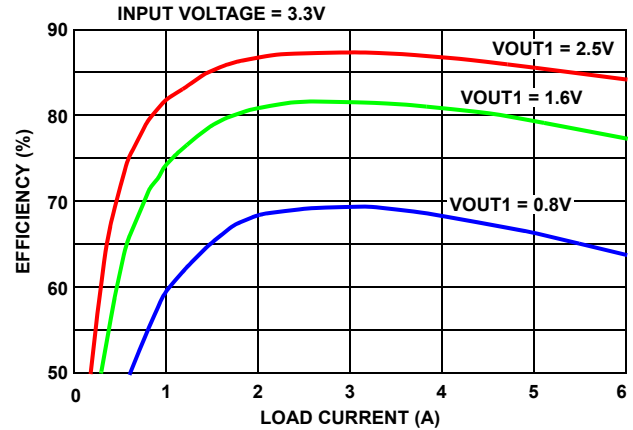

FIGURE 7. EFFICIENCY vs LOAD CURRENT FOR 3 OUTPUT VOLTAGES

Summary

The ISL6529EVAL1 is an adaptable evaluating tool which showcases the performance of the ISL6529C and ISL6529AC. Designed to meet the performance requirements of Graphics Card applications, it allows the user the flexibility to configure it for future designs as well. The following pages provide a schematic of the board, bill of materials, and layout drawings to support implementation of this solution.

References

Intersil documents are available on the web at <http://www.intersil.com>.

- [1] ISL6529 Data Sheet, Intersil Corporation, File No. FN9070.

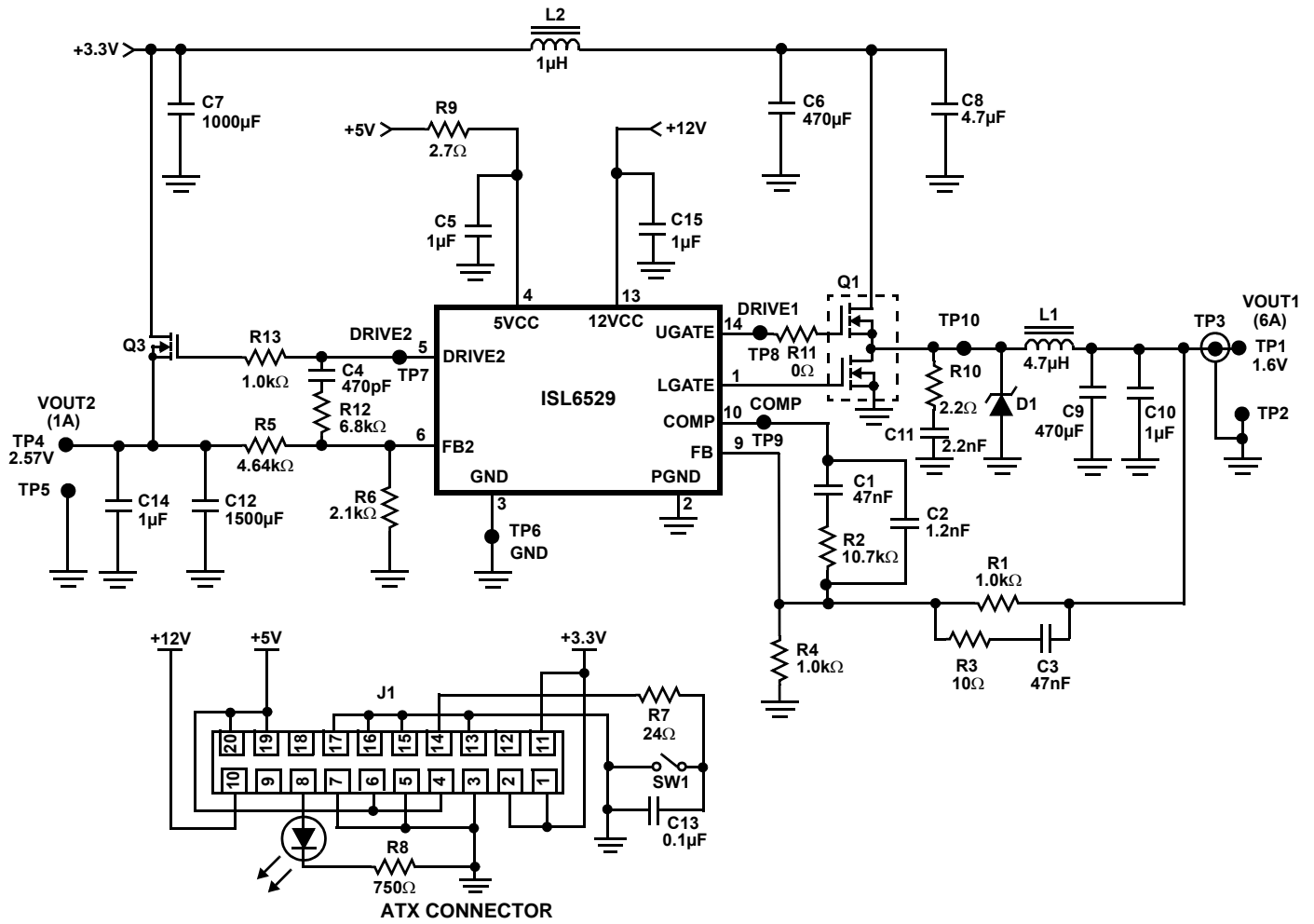

FIGURE 8. SCHEMATIC DIAGRAM OF ISL6529EVAL1 BOARD

Application Note 1134

ISL6529EVAL1 Bill of Materials

QTY	REFERENCE	DESCRIPTION	PACKAGE	VENDOR	PART NO.
2	C1, C3	47nF ±5%, 25V, X7R, Ceramic Capacitor	0603	Various	
1	C2	1.2nF ±5%, 25V, X7R, Ceramic Capacitor	0603	Various	
1	C4	470pF ±5%, 25V, X7R, Ceramic Capacitor	0603	Various	
4	C5, C10, C14, C15	1µF, 25V, X5R, Ceramic Capacitor	0805	Various	
2	C6, C9	470µF, 6.3V, Organic Capacitor	SM	Sanyo	SVP Series 6SVP470MX
1	C7	1000µF, 6.3V, Aluminum Capacitor	SM	Sanyo	6.3CV1000AX
1	C8	4.7µF, 16V, Y5V, Ceramic Capacitor	1206	Various	
1	C11	2.2nF, 25V, X7R, Ceramic Capacitor	603	Various	
1	C12	1500µF, 6.3V, Aluminum Capacitor	SM	Sanyo	6.3CV1500AX
1	C13	0.1µF, 25V, X5R, Ceramic Capacitor		Various	
1	D1	Schottky Rectifier	SMA	ON	MBRS1100T3
1	J1	ATX Power Header		Molex Jameco	39-29-9203 147379
1	L1	4.7µH, 5.2A Inductor	SMT	TOKO	919AS-4R7M=P3
1	L2	1.0µH, 9.7A Inductor	SMT	TOKO	919AS-1R0N=P3
1	LP1	Miniature LED, Through-Board Indicator	SM	Chicago Lamp, Inc.	CMD91-21SRC/TR10
1	Q1	Dual N-Channel MOSFET Transistors	SO-8	IR	IRF7313
1	Q3	N-Channel MOS Transistor	D-PAK	ON	MTD3055VL
2	R1, R4	Resistor, 1.0kΩ, 1%, 1/10W	0603	Various	
1	R2	Resistor, 10.7kΩ, 1%, 1/10W	0603	Various	
1	R3	Resistor, 10Ω, 5%, 1/10W	0603	Various	
1	R5	Resistor, 4.64kΩ, 1%, 1/10W	0603	Various	
1	R6	Resistor, 2.1kΩ, 1%, 1/10W	0603	Various	
1	R7	Resistor, 24Ω, 5%, 1/10W	0603	Various	
1	R8	Resistor, 750Ω, 5%, 1/10W	0603	Various	
1	R9	Resistor, 2.7Ω, 5%, 1/10W	0603	Various	
1	R10	Resistor, 2.2Ω, 5%, 1/10W	0603	Various	
1	R11	Resistor, 0Ω, 5%, 1/10W	0603	Various	
1	R12	Resistor, 6.8kΩ, 1%, 1/10W	0603	Various	
1	R13	Resistor, 1.0kΩ, 5%, 1/10W	0603	Various	
1	SW1	Switch, DPST	SMT	CK	GT11MSCK
5	TP1, TP2, TP4, TP5, TP6	Large Test Points	Thru Hole	Keystone	1514-2
1	TP3	Probe Socket	Thru Hole	Tektronics	131-4353-00
4	TP7, TP8, TP9, TP10	Small Test Point	Thru Hole	Jolo	SPCJ-123-01
1	U1	Dual Regulator Controller	SO-8	Intersil	ISL6529CB
1	PC Board	2 Layers	2 Oz Copper	Various	

ISL6529EVAL1 Evaluation Board Layout

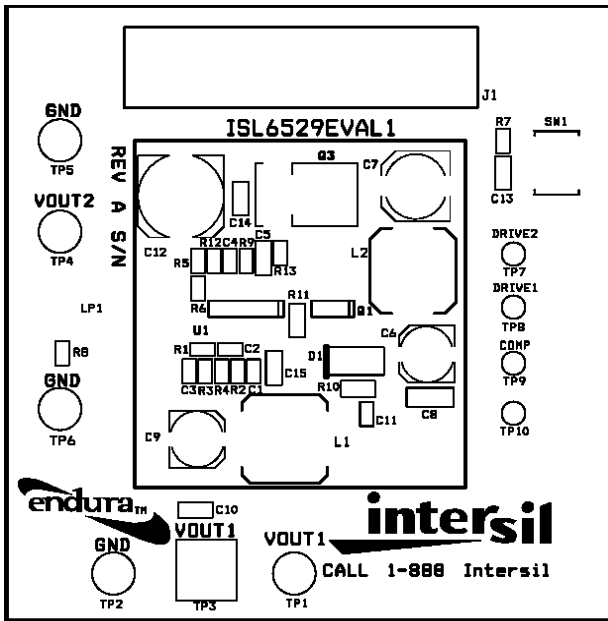

FIGURE 1. TOP SILK SCREEN

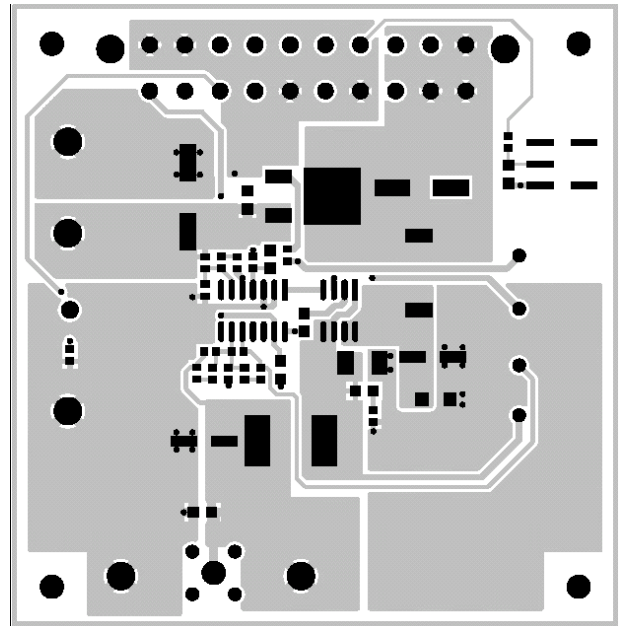

FIGURE 2. TOP LAYER

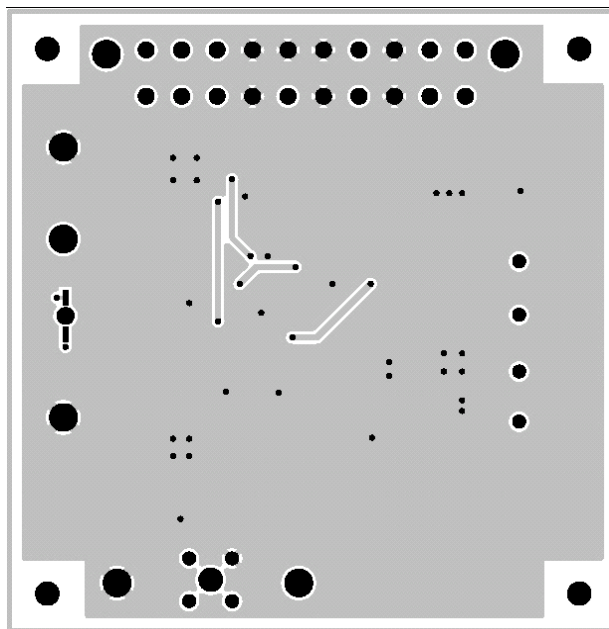

FIGURE 3. BOTTOM LAYER

Intersil Corporation reserves the right to make changes in circuit design, software and/or specifications at any time without notice. Accordingly, the reader is cautioned to verify that the Application Note or Technical Brief is current before proceeding.

For information regarding Intersil Corporation and its products, see www.intersil.com